

Panasonic®

Personal Computer

OPERATING INSTRUCTIONS

Model No. **CF-28 Series**

TOUGHBOOK

2000 XP

Contents

Getting Started

Read Me First	3
First-time Operation	9

Reference Manual

- Read Me First
- Key Combinations
- LED Indicators

Operation

Starting Up/Shutting Down	14
Touch Pad (Basic Operation)	17
Reference Manual	18

Reference Manual

- Touch Pad (Advanced)
- Touchscreen*
- Panasonic Hand Writing Functions
- Security Measures
- Computing on the Road
- Battery Power
- Multimedia Pocket
- PC Cards
- RAM Module
- Port Replicator
- Printer
- External Display
- USB Device
- Infrared Data Communications
- Modem
- Hard Disk Drive
- Setup Utility

*Only for models with touchscreen

Troubleshooting

List of Error Codes	19
Dealing with Problems (Summary)	21
Reinstalling Software	24

Reference Manual

- Technical Information
- DMI Viewer
- List of Error Codes
- Dealing with Problems (Advanced)

Appendix

LIMITED USE LICENSE AGREEMENT	26
Names and Functions of Parts	28
Specifications	30
LIMITED WARRANTY	32

[Additional Manual]

Reference Manual

This manual can be accessed on your computer.
Refer to page 18 on how to access the Reference Manual.

Getting Started

Operation

Troubleshooting

Appendix

Customer's Record

Model No.* _____	Dealer's Name _____
Serial No. _____	_____
or	
Code No. _____	Dealer's Address _____
Date of Purchase _____	

* For the Model No., insert the 12 digit number (for example, CF-28PTJAZQM) located on the bottom of the computer.

Introduction

Thank you for purchasing the Panasonic computer. Read the operating instructions thoroughly for proper operation of your new computer.

Illustrations and Terminology in this Manual

NOTE:

NOTE provides a useful fact or helpful information.

CAUTION:

CAUTION indicates a condition that may result in minor or moderate injury.

WARNING:

WARNING indicates a hazard that may result in moderate or serious injury.

[Start] - [Run]:

This illustration means to click [Start], then to click [Run].
(For some applications, you may need to double-click.)

 :

This illustration means to press the [Enter] key.

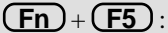
 :

This illustration means to press and hold the [Fn] key, then press the [F5] key.

 :

Information for Microsoft® Windows® 2000 Professional users.

 :

Information for Microsoft® Windows® XP Professional users.



 Reference Manual :

Where to go for referred information.

This illustration means to refer to the Reference Manual, which is available on your computer. Refer to page 18 on how to access this manual.

- Some of the illustrations in this manual may differ slightly in shape from the actual items in order to make the explanation easier to understand.
- Circular media such as CD-ROM and DVD-ROM are described as “discs”.
- The “CD Drive” is a description about drives, such as DVD-ROM, CD-ROM, CD-R/RW, and DVD-ROM & CD-R/RW drives.
- This manual covers two types of models, as distinguished by the type of LCD screen (models with touchscreen and models without touchscreen).
- If the user has logged on without “Administrator authority,” some functions may not be executable, and some screens may be not displayed as shown in this manual. If this happens, log on with Administrator authority to enable these functions.

Copyright

This manual is copyrighted by Matsushita Electric Industrial Co., Ltd. with all rights reserved. No part of this manual may be reproduced in any form without the prior written permission of Matsushita Electric Industrial Co., Ltd. No patent liability is assumed with respect to the use of the information contained herein.

©2002 Matsushita Electric Industrial Co., Ltd. All Rights Reserved.

Disclaimer

Computer specifications and manuals are subject to change without notice. Matsushita Electric Industrial Co., Ltd. assumes no liability for damage incurred directly or indirectly from errors, omissions or discrepancies between the computer and the manuals.

Trademarks

PS/2™ is a trademark of International Business Machines Corporation.

Microsoft® and Windows® are registered trademarks of Microsoft Corporation of the United States and/or other countries.

Intel, Pentium and SpeedStep™ are registered trademarks of Intel Corporation.

Adobe® and Acrobat® are either registered trademarks or trademarks of Adobe Systems Incorporated in the United States and/or other countries.

Panasonic® is a registered trademark of Matsushita Electric Industrial Co., Ltd.

Read Me First

For U.S.A.

Federal Communications Commission Radio Frequency Interference Statement

Note: This equipment has been tested and found to comply with the limits for a Class B digital device, pursuant to Part 15 of the FCC Rules. These limits are designed to provide reasonable protection against harmful interference in a residential installation. This equipment generates, uses and can radiate radio frequency energy and, if not installed and used in accordance with the instructions, may cause harmful interference to radio communications. However, there is no guarantee that interference will not occur in a particular installation. If this equipment does cause harmful interference to radio or television reception, which can be determined by turning the equipment off and on, the user is encouraged to try to correct the interference by one or more of the following measures:

- Reorient or relocate the receiving antenna.
- Increase the separation between the equipment and receiver.
- Connect the equipment into an outlet on a circuit different from that to which the receiver is connected.
- Consult the Panasonic Service Center or an experienced radio/TV technician for help.

Warning

To assure continued compliance, use only shielded interface cables when connecting to a computer or peripheral. Also, any changes or modifications not expressly approved by the party responsible for compliance could void the user's authority to operate this equipment.

This device complies with Part 15 of the FCC Rules. Operation is subject to the following two conditions:

- (1) This device may not cause harmful interference, and
- (2) This device must accept any interference received, including interference that may cause undesired operation.

Responsible Party: Matsushita Electric Corporation of America
One Panasonic Way
Secaucus, NJ 07094
Tel No:1-800-LAPTOP-5 (1-800-527-8675)

FCC Regulation Notice for modem This equipment contains a FCC approved modem.

Manufacturer of modem: Aztech Labs, Inc.
Model No. MP3930V-W(C)



1. This equipment complies with Part 68 of the FCC rules. On the computer is a label that contains, among other information, the FCC registration number and ringer equivalence number (REN) for this equipment. If required, this information must be provided to the telephone company.
2. An FCC compliant telephone cord and modular plug is provided with this equipment. This equipment is designed to be connected to the telephone network or premises wiring using a compatible modular jack which is Part 68 compliant. See Installation Instructions for details.

3. The REN is used to determine the quantity of devices which may be connected to the telephone line. Excessive RENs on the telephone line may result in the devices not ringing in response to an incoming call. In most, but not all area, the sum of RENs should not exceed five (5.0). To be certain of the number of devices that may be connected to a line, as determined by the total RENs, contact the local telephone company.
4. If your telephone equipment cause harm to the telephone network, the telephone company will notify you in advance that temporary discontinuance of service may be required. But if advance notice isn't practical, the telephone company will notify the customer as soon as possible. Also, you will be advised of your right to file a complaint with the FCC if you believe it is necessary.
5. The telephone company may take changes in it's facilities, equipment, operations or procedures that could affect the operation of the equipment. If this happens the telephone company will provide advance notice in order for you to make necessary modifications to maintain uninterrupted service.
6. If trouble is experienced with this equipment, for repair or warranty information, please contact Matsushita Electric Corporation of America at DIAL TOLL FREE 1-800-LAPTOP5 (1-800-527-8675). If the equipment is causing harm to the telephone network, the telephone company may request that you disconnect the equipment until the problem is resolved.
7. There are no user serviceable parts contained in this equipment.
8. This equipment may not be used on coin service provided by the telephone company. Connection to party lines is subject to state tariffs.
9. The Telephone Consumer Protection Act of 1991 makes it unlawful for any person to use a computer or other electronic device to send any message via a telephone fax machine unless such message clearly contains in a margin at the top or bottom of each transmitted page or on the first page of the transmission, the date and time it is sent and an identification of the business or other entry, or other individual sending the message and the telephone number of the sending machine or such business, other entity, or individual. In order to program this information into your fax software, you should refer to the manual of the Fax software being used.
10. According to the FCC's electrical safety advisory, we recommend that you may install an AC surge arrestor in the AC outlet to which this equipment is connected. Telephone companies report that electrical surges, typically lightning transients, are very destructive to customer terminal equipment connected to AC power sources and that this is a major nationwide problem.

"Caution: To reduce the risk of fire, use only No.26 AWG or larger telecommunication line cord."

"ATTENTION: Pour réduire le risque d'incendie, utiliser uniquement des conducteurs de télécommunications 26 AWG ou de section supérieure."

Notice for the products using LCD

This product uses one or more fluorescent lamps containing a small amount of mercury. It also contains lead in some components. Disposal of these materials may be regulated in your community due to environmental considerations. For disposal or recycling information please contact your local authorities, or the Electronics Industries Alliance: <<http://www.eiae.org/>>

Read Me First

For Canada

Industry Canada (IC) Notice for modem

This equipment contains an Industry Canada approved modem unit. The Industry Canada label is affixed on the modem unit.

EQUIPMENT ATTACHMENT LIMITATIONS

“NOTICE: The Industry Canada label identifies certified equipment. This certification means that the equipment meets telecommunications network protective, operational and safety requirements as prescribed in the appropriate Terminal Equipment Technical Requirements document(s). The Department does not guarantee the equipment will operate to the user’s satisfaction.

Before installing this equipment, users should ensure that it is permissible to be connected to the facilities of the local telecommunications company. The equipment must also be installed using an acceptable method of connection. The customer should be aware that compliance with the above conditions may not prevent degradation of service in some situations.

Repairs to certified equipment should be coordinated by a representative designated by the supplier. Any repairs or alterations made by the user to this equipment, or equipment malfunctions, may give the telecommunications company cause to request the user to disconnect the equipment.

Users should ensure for their own protection that the electrical ground connections of the power utility, telephone lines and internal metallic water pipe system, if present, are connected together. This precaution may be particularly important in rural areas. Caution: Users should not attempt to make such connections themselves, but should contact the appropriate electric inspection authority, or electrician, as appropriate.”

“NOTICE: The Ringer Equivalence Number (REN) assigned to each terminal device provides an indication of the maximum number of terminals allowed to be connected to a telephone interface. The termination on an interface may consist of any combination of devices subject only to the requirement that the sum of the Ringer Equivalence Numbers of all the devices does not exceed 5.”

REN: See bottom of the computer

RESTRICTIONS CONCERNANT LE RACCORDEMENT DE MATÉRIEL

“AVIS: L’étiquette d’Industrie Canada identifie le matériel homologué. Cette étiquette certifie que le matériel est conforme aux normes de protection, d’exploitation et de sécurité des réseaux de télécommunications, comme le prescrivent les documents concernant les exigences techniques relatives au matériel terminal. Le Ministère n’assure toutefois pas que le matériel fonctionnera à la satisfaction de l’utilisateur.

Avant d’installer ce matériel, l’utilisateur doit s’assurer qu’il est permis de le raccorder aux installations de l’entreprise locale de télécommunication. Le matériel doit également être installé en suivant une méthode acceptée de raccordement. L’abonné ne doit pas oublier qu’il est possible que la conformité aux conditions énoncées ci-dessus n’empêche pas la dégradation du service dans certaines situations.

Les réparations de matériel homologué doivent être coordonnées par un représentant désigné par le fournisseur. L’entreprise de télécommunications peut demander à l’utilisateur de débrancher un appareil à la suite de réparations ou de modifications effectuées par l’utilisateur ou à cause de mauvais fonctionnement.

Pour sa propre protection, l’utilisateur doit s’assurer que tous les fils de mise à la terre de la source d’énergie électrique, des lignes téléphoniques et des canalisations d’eau métalliques, s’il y en a, sont raccordés ensemble. Cette précaution est particulièrement importante dans les régions rurales. Avertissement: L’utilisateur ne doit pas tenter de faire ces raccordements lui-même; il doit avoir recours à un service d’inspection des installations électriques, ou à un électricien, selon le cas.”

“AVIS: L’indice d’équivalence de la sonnerie (IES) assigné à chaque dispositif terminal indique le nombre maximal de terminaux qui peuvent être raccordés à une interface. La terminaison d’une interface téléphonique peut consister en une combinaison de quelques dispositifs, à la seule condition que la somme d’indices d’équivalence de la sonnerie de tous les dispositifs n’excède pas 5.”

IES: Voir sous le fond de l’ordinateur

Important Safety Instructions / Importantes Mesures De Sécurité

When using your telephone equipment, basic safety precautions should always be followed to reduce the risk of fire, electric shock and injury to persons, including the following:

1. Do not use this product near water, for example, near a bath tub, wash bowl, kitchen sink or laundry tub, in a wet basement or near a swimming pool.
2. Avoid using a telephone (other than a cordless type) during an electrical storm. There may be a remote risk of electric shock from lightning.
3. Do not use the telephone to report a gas leak in the vicinity of the leak.
4. Use only the power cord and batteries indicated in this manual. Do not dispose of batteries in a fire. They may explode. Check with local codes for possible special disposal instructions.

SAVE THESE INSTRUCTIONS

Certaines mesures de sécurité doivent être prises pendant l’utilisation de matériel téléphonique afin de réduire les risques d’incendie, de choc électrique et de blessures. En voici quelquesunes:

1. Ne pas utiliser l’appareil près de l’eau, p.ex., près d’une baignoire, d’un lavabo, d’un évier de cuisine, d’un bac à laver, dans un sous-sol humide ou près d’une piscine.
2. Éviter d’utiliser le téléphone (sauf s’il s’agit d’un appareil sans fil) pendant un orage électrique. Ceci peut présenter un risque de choc électrique causé par la foudre.
3. Ne pas utiliser l’appareil téléphonique pour signaler une fuite de gaz s’il est situé près de la fuite.
4. Utiliser seulement le cordon d’alimentation et le type de piles indiqués dans ce manuel. Ne pas jeter les piles dans le feu: elles peuvent exploser. Se conformer aux règlements pertinents quant à l’élimination des piles.

CONSERVER CES INSTRUCTIONS

Lithium Battery

Lithium Battery!

This computer contains a lithium battery to enable the date, time, and other data to be stored. The battery should only be exchanged by authorized service personnel.

Warning! A risk of explosion from incorrect installation or mis-application may possibly occur.

Pile au lithium!

Le micro-ordinateur renferme une pile au lithium qui permet de sauvegarder certaines données comme la date et l'heure notamment. Elle ne devra être remplacée que par un technicien qualifié.

Avertissement! Risque d'explosion en cas de non respect de cette mise en garde!

Precautions

The CF-28 was developed based on thorough research into the real-world portable computing environments. Exhaustive pursuit of usability and reliability under harsh conditions led to innovations such as the magnesium alloy exterior, vibration damped hard disk drive and floppy disk drive, flexible internal connections. The CF-28's outstanding engineering has been tested using the stiff MIL-STD- 810E (for vibration and shock) and IP (for dust and water) based procedures.

As with any portable computer device precautions should be taken to avoid any damage. The following usage and handling procedures are recommended.

Before putting the computer away, be sure to wipe off any moisture.

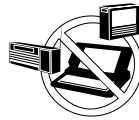

Avoid Radio Frequency Interference

Do not place the computer near a television or radio receiver.



Avoiding low-temperature burns

Avoid more than casual contact with any heat producing area of the notebook computer, AC adaptor, and any option or accessory you use with it. Even low heat, if warmer than body temperature, can cause a burn, if the skin is exposed to the heat source for a long enough period of time.



Avoid Magnetic Fields

Keep the computer away from magnets. Data stored on the hard disk may be lost.



Keep Small Objects Away

Do not insert paper clips or other small objects into the computer.



Do Not Disassemble the Computer

Do not attempt to disassemble your computer.



Avoid Excessive Force on the Display

Do not apply excessive downward force on the display when it is completely opened, especially when plugs and/or cables are connected to the rear of the computer.

● Peripherals

Incorrectly using peripheral devices may lead to a decrease in performance, an increase in temperature and/or damage your computer. For more information on peripheral devices, refer to the Reference Manual.

● Cables

Use of an interface cable longer than 3 m {9.84 feet} is not recommended.

Read Me First

Precautions (Battery Pack)

- Care should be exercised with regard to the following in order to avoid the possibility of overheating, fire or damage.



Avoid Heat

Do not throw the battery pack into a fire or expose it to excessive heat.



Keep Articles Away

Do not place the battery pack together with articles such as necklaces or hairpins when carrying or storing.



Do Not Disassemble

Do not insert sharp objects into the battery pack, expose it to bumps or shocks, deform, disassemble, or modify it.



Do Not Short

Do not short the positive (+) and negative (-) contacts.

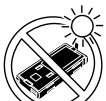

Avoid Extreme Heat, Cold and Direct Sunlight

Do not charge, use or leave the battery pack for extended periods where it will be exposed to direct sunlight, in a hot place (in an automobile on a sunny day, for example), or in a cold place.



Do Not Use With Any Other Computer

The battery pack is rechargeable and was intended for the specified computer or charger. Do not use it with a computer other than the one for which it was designed.



Do Not Put into a Microwave

Do not put the battery pack into a microwave oven or a pressurized chamber.





Stop Using

Should the battery emit an abnormal odor, become hot to the touch, become discolored, change shape, or become in any way different from normal, remove it from the computer or charger and stop using it.

- Do not touch the terminals on the battery pack. The battery pack may no longer function properly if the contacts are dirty or damaged.
- Do not expose the battery pack to water, or allow it to become wet.

- If the battery pack will not be used for a long period of time (a month or more), charge or discharge (use) the battery pack until the remaining battery level becomes 30% to 50% and store it in a cool, dry place.
- This computer prevents overcharging of the battery by recharging only when the remaining power is less than approx. 95% of capacity.
- The battery pack is not charged when the computer is first purchased. Be sure to charge it before using it for the first time. When the AC adaptor is connected to the computer, charging begins automatically.
- Should the battery leak and the fluid get into your eyes, do not rub your eyes. Immediately flush your eyes with clear water and see a doctor for medical treatment as soon as possible.

NOTE

- The battery pack may become warm during recharging or normal use. This is completely normal.
- Recharging will not commence outside of the allowable temperature range (0 °C to 50 °C {32°F to 122 °F})
 Reference Manual "Battery Power". Once the allowable range requirement is satisfied, charging begins automatically. Note that the recharging time varies based on the usage conditions. (Recharging takes longer than usual when the temperature is 10 °C {50 °F} or below.)
- If the temperature is low, the operating time is shortened. Only use the computer within the allowable temperature range.
- This computer has a high temperature mode function that prevents the degradation of the battery in high temperature environments. If the high temperature mode is enabled in the Setup Utility ( Reference Manual "Setup Utility"), a level of 100% in the [High Temperature] mode is about a level of 80% in the [Normal Temperature] mode.
- The battery pack is a consumable item. If the amount of time the computer can be run off a particular battery pack becomes dramatically shorter and repeated recharging do not restore its performance, the battery pack should be replaced with a new one.
- When a spare battery pack is to be carried in a pocket or bag, it is recommended that it be placed in a plastic bag so that its contacts are protected.
- Always power off the computer when it is not in use. Leaving the computer on when the AC adaptor is not connected will exhaust the remaining battery capacity.

Saving Data on the Hard Disk

- **Do not expose your computer to shock.**
Use care when handling your computer, shock may damage your hard disk or make your software applications and data unusable.
 - **Do not power off your computer while software applications are running or hard disk drive indicator (HDD) is on.**
Properly shut Windows* down to avoid problems.
 - **Save all valuable data to floppy disks.**
Backing up data to floppy disks will limit damage should trouble occur to your computer or should you inadvertently change or erase data.
 - **Use the security function for all important data.** (Reference Manual "Security Measures")
- * **Windows 2000** : This computer uses Microsoft® Windows® 2000 Professional.
Windows XP : This computer uses Microsoft® Windows® XP Professional.

Hard Disk Lock

When the Hard Disk Lock is set to [Enable], it is impossible to read/write data from/to the hard disk when the hard disk is installed in a different computer, since a password is also set for the hard disk. When the hard disk is returned to the original computer, you can read and write data as before. In this case, however, make the settings in the Setup Utility exactly the same as they were before the hard disk was removed. (Note that this Hard Disk Lock does not guarantee complete protection of data.) (Reference Manual "Security Measures")

Saving Data on Floppy Disks

- **Do not power down your computer or press the disk eject button while the MP indicator (MP) is on.**
Doing so may damage the data on the floppy disk and render the floppy disk useless.
- **Use care when handling floppy disks.**
To protect the data on your floppy disks or to prevent a floppy disk from becoming stuck in your computer, avoid the following:
 - Sliding the shutter on the floppy disk manually.
 - Exposing the floppy disk to a magnetic field.
 - Storing the floppy disk in locations prone to high temperatures, low pitched noise, dampness, or dust.
 - Applying more than one label on the floppy disk.
- **Confirm the contents of a floppy disk before formatting it.**
Confirm that no important data is on the floppy disk, because all data on the floppy disk will be erased.
- **Use the write-protect tab.**
This is a must for preserving important data. This prevents your data from being erased or overwritten.

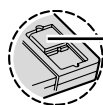

Write-protect Tab
Write Enable

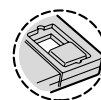

Write Disable

Computer Viruses

Users are advised to purchase the latest versions of virus protection software and use them regularly.

We recommend you run the software:

- When booting your computer.
- After receiving data.

We recommend that you check data received on disks or from external sources, such as data downloaded from the Internet, e-mail, etc. (For compressed files, uncompress them before running a check).

When Using Peripheral Devices

Pay strict attention to the following points to avoid damage to the computer, peripheral devices, cables, etc. Also, in addition to following this manual, carefully read the instruction manuals for the peripheral devices being used.

- Connect the devices properly, paying close attention to the condition and position of the connectors.
- If a connection cannot be made easily, do not apply undue force; check once more to confirm the condition and position of the connector (alignment of pins, etc.) .
- If the connector has holding screws, fasten the screws firmly.
- Do not carry the computer with cables attached, and do not pull on the cables forcefully.

A Characteristic of Transflective Display (Only for models with 12.1 type LCD)

Immediately after the computer is turned off or enters the standby mode, you may notice a black pattern appearing temporarily at the edges of the display. This is a characteristic of the transflective display and is not a malfunction.

Read Me First

Usage Environment

- Place the computer on a flat stable surface.
- In use: Temperature: 5 °C to 35 °C {41 °F to 95 °F}
Humidity: 30% to 80% RH (No condensation)
- Not in use: Temperature: -20 °C to 60 °C {-4 °F to 140 °F}
Humidity: 30% to 90% RH (No condensation)

Handling

- This computer has been designed so as to minimize shock to the LCD and hard disk drive, the leakage of liquid (e.g., water) on to the keyboard, etc., but no warranty is provided against such trouble. Therefore, as a precision instrument, be extremely careful in the handling.
- Do not drop or hit your computer against solid objects.
- Do not carry your computer when it is on.
- Remove all cables before transporting your computer.
- We recommend preparing a fully charged battery (and optional charger, if possible).
When transporting spare batteries inside a package, briefcase, etc., it is recommended that the batteries be stored in a plastic bag.
- Do not place the computer upright or allow it to tip over. When the computer receives extremely strong shock after falling, the hard disk or floppy disk drive, etc., may become inoperable.
- Do not carry the computer while the display is open, or carry it by gripping the display.
- Do not put anything (e.g., a piece of paper) between the display and keyboard.
- Always carry your computer with you when traveling. Never check it in with luggage. For use of the computer inside an aircraft, we recommend asking the airlines regarding their policy on this issue.
- It is a good idea to make backup copies on disks and carry them with you.
- Do not leave a disk in the drive while transporting your computer.

Maintenance

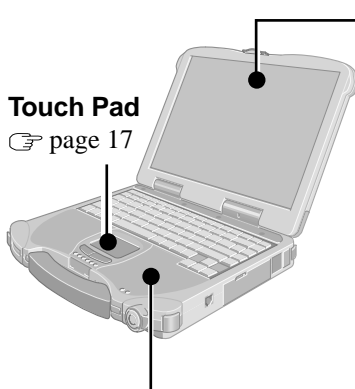

Display

<Models with touchscreen>

Use the soft cloth included with the computer. (For more information, refer to “Suggestions About Cleaning the LCD Surface” that come with the soft cloth.)

If the Protective Film becomes dirty or damaged, it may be time to replace your Protective Film. The Protective Film is a disposable item. To find out the model number of your Protective Film, contact Panasonic Technical Support. (For more information, refer to the “Operating Instructions” that come with the Protective Film.)

CAUTION

Do not touch or use a touchscreen before you re-attach a Protective Film, as you may leave a mark or a scratch on the touchscreen.

Areas excluding the display

Wipe these areas with a soft cloth, after applying water or detergent diluted with water to the soft cloth and firmly wringing out excess water.

<Models without touchscreen>

Avoid using water when cleaning the panel. Ingredients included in water may leave residue and reduce readability of the screen.

<When cleaning dust/dirt>

Avoid rubbing off dust/dirt with cloth since it may leave scratch on the screen.

Sweep dust/dirt with fine brush, then wipe it with “dry” soft cloth used for cleaning glasses.

<When cleaning oily surface>

Apply camera lens cleaner on a soft gauze and clean it with gentle force. Then, wipe with dry soft cloth used for cleaning glasses.

CAUTION



- Do not use benzene, thinner, or rubbing alcohol. Doing so may adversely affect the surface, e.g., discoloration. In addition, do not use commercially-available household cleaners and cosmetics, as they may contain components harmful to the surface.
- Do not directly add or spray water or detergent. If liquid enters the inside of the computer, it may cause it to work improperly or be damaged.

First-time Operation

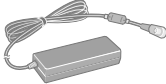

Read the steps below to help you learn what parts are included, and to gain an understanding of some basic computer-related operations.

1 Confirm the inclusion of all parts

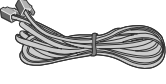
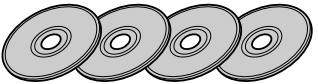
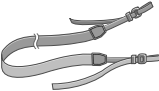
Make sure the parts shown in the figure have been supplied. If any of these items are missing or is not working properly, contact Panasonic Technical Support.

AC Adaptor 1  Model No : CF-AA1653	AC Cord 1 	Battery Pack 1  Model No : CF-VZSU18
Modem Telephone Cable ... 1 	Product Recovery CD-ROM 	
Strap 1  (☞ Page 28)	Operating Instructions (This book) 1 Windows® Book 1	

<Only for Models with touchscreen>

Soft Cloth 1 	Stylus 1  (☞ Reference Manual "Touchscreen")
--	--

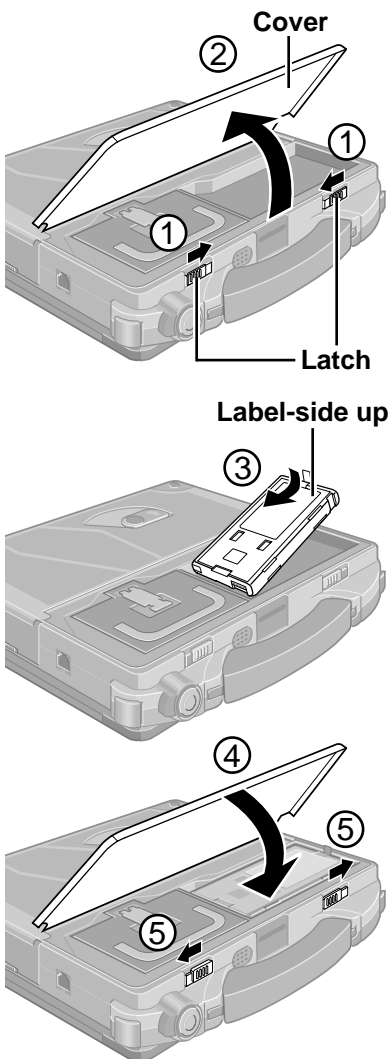

2 Read the LIMITED USE LICENSE AGREEMENT (☞ page 26)

Before removing the seal covering the power switch, read the LIMITED USE LICENSE AGREEMENT.

3 Insert the battery pack

- ① Turn your computer over, and slide the latches inward.
- ② Lift open the cover holding both sides and remove the cover.
- ③ Insert the battery pack into the computer with the label-side up.

CAUTION

- Be sure the battery pack is properly connected to the connector.
- Do not touch the terminals on the battery pack and the computer. The battery pack may no longer function properly if the contacts are dirty or damaged. Also, the computer may not operate properly.

- ④ Put the cover back into place holding both sides.
- ⑤ Slide the latches outward.

CAUTION

- If the cover is not attached properly, the battery may fall out while the computer is being carried.
- When attaching the cover, be careful not to get your fingers and the tab caught in the cover.

First-time Operation

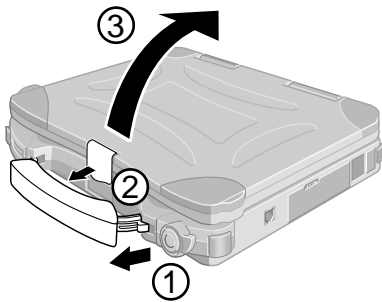
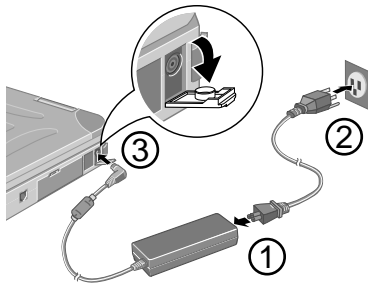

Power Indicator ①

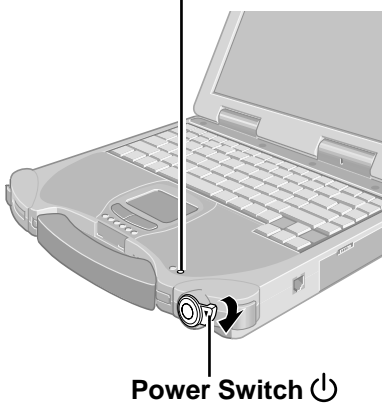

4 Connect your computer to a power outlet

CAUTION

- Be sure the AC adaptor is connected until completing Step 8 on page 11.
- When closing the cover, first insert the top of the cover.



Handling the AC adaptor

- Do not twist or pull the AC power cord forcefully. Doing so may damage the connections.
- Use only the specified AC adaptor with your computer. Using an AC adaptor other than the one supplied might damage the battery and/or the computer.
- When the DC plug is not connected to the computer, disconnect the AC cord from your AC wall outlet.
- Problems such as sudden voltage drops may arise during periods of thunder and lightning. Since this could adversely affect your computer, an uninterruptible power source (UPS) is highly recommended unless the battery pack is installed.

5 Open the display

- ① Pull the carrying handle forward.
- ② Lift up the latch.
- ③ Lift open the display.

NOTE

When using the computer for the first time, do not connect any peripheral device except the battery pack and AC adaptor to the computer.

6 Turn your computer on

Rotate the power switch clockwise and hold it for approximately one second until the power indicator turns on before releasing it.

CAUTION

- Do not rotate the power switch repeatedly.
- Once the computer is powered off, you must wait at least ten seconds before powering it on again.

NOTE

The power saving function is factory set, so if there is no input from a key, the touch pad, the touchscreen (only for models with touchscreen) or an external mouse (when one is connected) for a certain interval of time, the power to the LCD and hard disk may be turned off. The LCD will resume operation when the touch pad, the touchscreen (only for models with touchscreen) or an external mouse (when one is connected) is used or a key is pressed.

The power to the LCD may be turned off while Windows is setting up or even when an application software is being installed. In this case, because it is conceivable that a selection dialog box will be shown, do not press **(Space)** or **(Enter)** to attempt to resume from this condition as doing so may trigger a selection, but instead, press a key unrelated to the direct triggering of a selection, like **(Ctrl)**.

In addition, when the computer is left alone, it automatically enters the standby or hibernation mode (☞ Reference Manual “Standby/Hibernation Functions”). The computer will resume by rotating the power switch.

7 Select the Operating System

Windows 2000 and Windows XP are preinstalled on this computer. After one of them is selected with the following procedure, only that Operating System can be used.

- ① At the screen for the agreement of the selection of the Operating System, press **(Y)**.
- ② With the number keys, select either Windows 2000 or Windows XP.
(The selection of the Operating System is only performed the first time the computer is started up. A change cannot be made after the selection.)
- ③ At the confirmation message, press **(Y)**. The Operating System preparation will start, during which the computer will restart.

CAUTION

Do not touch the keyboard. If you accidentally touch the keyboard and the cancel confirmation menu is displayed, do not cancel.

- ④ When the screen indicating the completion of the Operating System preparation is displayed, press any key.
The computer will restart.

8 Setup Windows

Moving the cursor (↔) or clicking buttons can be performed with the touch pad.

NOTE

<Only for models with 13.3 type LCD>

During the Windows setup procedure, the desktop will be displayed as a small screen in the center of the LCD. After the setup procedure is completed and the computer is restarted, the desktop will be displayed as a full screen.

Windows 2000

CAUTION

Do not press any key or move the touch pad until [Windows 2000 Professional Setup] is displayed.

- ① At the [Welcome to the Windows 2000 Setup Wizard], select [Next].
- ② After reading the agreement, select [I accept this agreement] or [I don't accept this agreement], then select [Next].

NOTE

If [I don't accept this agreement] is selected, the Windows setup will be aborted.

- ③ Select settings for your region, then select [Next].
- ④ Enter your name and organization and then select [Next].
- ⑤ Enter your computer name and administrator password and then select [Next].

CAUTION

Remember this password! If the password is forgotten, Windows 2000 cannot be operated.

- ⑥ Enter the correct date, time and time zone and then select [Next].
You can also complete these settings at a later time.
- ⑦ Enter your administrator password and then select [OK].

<Only for models with touchscreen>

If the cursor can not be pointed correctly with the stylus, perform [Calibration] in [Start] - [Settings] - [Control Panel] - [Mouse] - [TouchScreen].

First-time Operation

Windows XP

CAUTION

Do not press any key or move the touch pad until [Windows XP Professional Setup] is displayed.

- ① At the [Welcome to the Windows XP Setup Wizard], select [Next].
- ② After reading the agreement, select [I accept this agreement] or [I don't accept this agreement], then select [Next].

NOTE

If [I don't accept this agreement] is selected, the Windows setup will be aborted.

- ③ Select settings for your region, then select [Next].
- ④ Enter your name and organization and then select [Next].
- ⑤ Enter your computer name and administrator password and then select [Next].

CAUTION

Remember this password! If the password is forgotten, Windows XP cannot be operated.

- ⑥ Enter the correct date and time, then select [Next].
You can also complete these settings at a later time.
- ⑦ Enter your administrator password and select .

<Only for models with touchscreen>

If the cursor can not be pointed correctly with the stylus, perform [Calibration] in [Start] - [Control Panel] - [Printers and Other Hardware] - [Mouse] - [TouchScreen].

This concludes the first-time use operation guidelines.

NOTE

Windows XP

- You can select Classic view for the Control Panel or select the Classic Start menu. You can also change the way a user logs on or off.
The procedure in this manual uses the method or view of the Windows XP default setting (not Classic view or Classic Start menu etc.).
- **<Resetting the password>**
Windows XP has a function to reset a forgotten password.
To use this function, you need to create a password reset disk beforehand following the steps below.
 - 1 Select [Control Panel] - [User Accounts] and select the account you used to logon.
 - 2 Select [Prevent a forgotten password] from the [Related Tasks] menu and create a password reset disk following the on-screen instructions.
 - Store the password reset disk in a safe place.
 - Only the logon password for each account can be reset.
The password set in the Setup Utility cannot be reset.

Create BACKUP Disks for Reinstallation

When [You do not need to make "BACKUP DISK"] is displayed (procedure ② below), there is no need to create a BACKUP DISK. If this message is not displayed, create backup disks for reinstallation. To create backup disks, the floppy disk drive and formatted 2HD floppy disks are needed.

① Make sure a disk is not in the write-protected state and set it.

② **Windows 2000**

Select [Start] - [Programs] - [Panasonic] - [Create Backup Disk] and follow the on-screen instructions.

Windows XP

Select [Start] - [All Programs] - [Panasonic] - [Create Backup Disk] and follow the on-screen instructions.

③ Place a label identifying the contents on each disk.

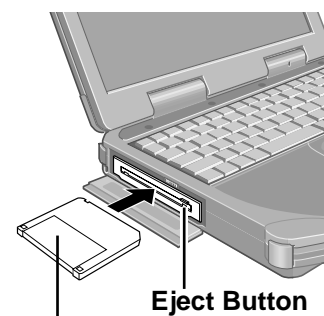

Label-side up
Insert the shutter-side
headfirst.

● **Names of created BACKUP DISK**

FIRSTAID FD (When the display for creating the UPDATE FD is shown, create the disk by following the on-screen instructions.)

CAUTION

- Store the floppy disks in a safe place. They will enable you to return your computer to factory default settings should any problems occur.
- When creating backup disks and the message [Insufficient files to copy] is displayed, select [OK] and then contact Panasonic Technical Support.
- While the MP indicator (MP) is on, do not remove the floppy disk, power down your computer or enter either the standby or hibernation mode (☞ Reference Manual "Standby/Hibernation Functions").
- When creating backup disks, do not run any other application program.
- Be sure to create the backup disk.

If a backup disk is not created, it will be impossible to return the computer to its original state. In this case, contact Panasonic Technical Support.

Starting Up/Shutting Down

Starting Up

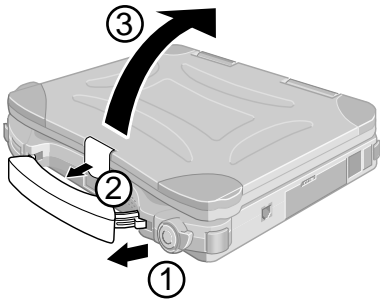

1 Open the display

- ① Pull the carrying handle forward.
- ② Lift up the latch.
- ③ Lift open the display.

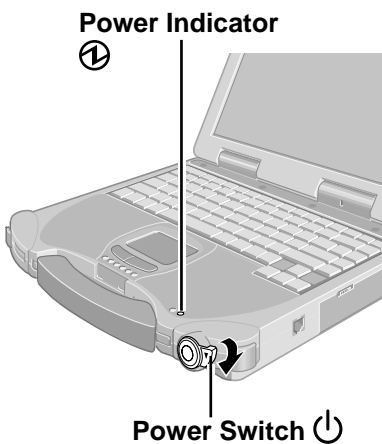

2 Turn your computer on

Rotate the power switch clockwise and hold it for approximately one second until the power indicator turns on before releasing it.

CAUTION

- Under the condition that both the AC adaptor and the port replicator are not connected, the power will not go on if the display is closed.
- After confirming that the power indicator has turned on, avoid the following until Windows has completed loading.
 - Connecting or disconnecting the AC adaptor.
 - Touching the power switch.
 - Performing any keyboard, touch pad, touchscreen (only for models with touchscreen), or external mouse operations.
 - Closing the display.
- Once the computer is powered off, you must wait at least ten seconds before powering it on again.
- When the computer is turned on in a low-temperature environment, start-up may take longer than usual, in order to ensure stable operation of the computer's systems (a few minutes or more).
- When the CPU temperature rises, the computer may not power on to prevent the CPU from overheating. Should this happen, allow the computer to cool down then switch the power on again.
If the computer still does not power on, contact Panasonic Technical Support.

● If security indicator () is displayed,

you must first enter your password ( Reference Manual "Security Measures")

Upon entering your password* and pressing **Enter** .

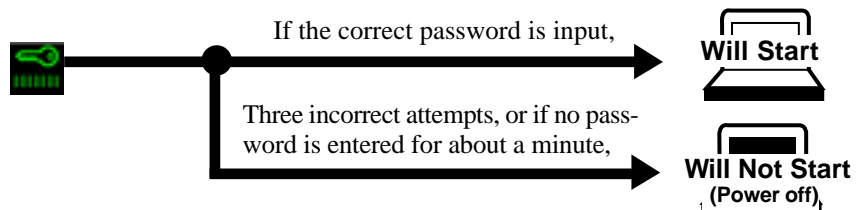

* Supervisor Password or User Password set in the Setup Utility (not the Windows password).

● When an application or file that was previously displayed appears on your screen,

the standby or hibernation mode ( Reference Manual "Standby/Hibernation Functions") has been set.

3 **Windows 2000**

Input your password

Wait for 10 seconds after confirming that the hard disk access has been completed, and input the user name and password, then select [OK]. Until the correct user name and password are entered, the computer will not operate.

Windows XP

Select User (only necessary when multiple accounts are created)

Wait for 10 seconds after confirming that the hard disk access has been completed, then select the user.

4 **Select your application**

You are able to start working on your computer.

NOTE

- The power saving function is factory set, so if there is no input from a key, the touch pad, the touchscreen (only for models with touchscreen) or an external mouse (when one is connected) for a certain interval of time, the power to the LCD and hard disk may be turned off. The LCD will resume operation when the touch pad, the touchscreen (only for models with touchscreen) or an external mouse (when one is connected) is used or a key is pressed.

The power to the LCD may be turned off while Windows is setting up or even when an application software is being installed. In this case, because it is conceivable that a selection dialog box will be shown, do not press **Space** or **Enter** to attempt to resume from this condition as doing so may trigger a selection, but instead, press a key unrelated to the direct triggering of a selection, like **Ctrl**.

In addition, when the computer is left alone, it automatically enters the standby or hibernation mode (☞ Reference Manual “Standby/Hibernation Functions”). The computer will resume by rotating the power switch.

Windows 2000

- When a new device has been installed or a new Windows Component has been added in [Start] - [Settings] - [Control Panel] - [Add/Remove Programs], [Insert Disk] may appear. Select [OK] and then specify [c:\winnt\cdimage] in place of [c:\sysprep\i386] or [A:], then select [OK].
e.g., [c:\winnt\cdimage\i386] in place of [A:\i386]

Windows XP

- When you create the first new account, you can only select a Computer Administrator account.
Only the added user account will be displayed in the Welcome screen. The Administrator's account created during Windows setup (when the computer is started up for the first time) will not be displayed.
- When switching to a different user with the Fast User Switching function, it may not be possible to set the settings of the display. In this case, log on with the administrator authority again, not using the Fast User Switching function, and try the operation once more.

Starting Up/Shutting Down

Shutting Down (power off your computer)

This procedure is shutting down without using the standby or hibernation function.

 Reference Manual “Standby/Hibernation Functions”)

1 Save important data and close each application

2 Display the shut down screen

Windows 2000

Select [Start] - [Shut Down].

Windows XP

Select [Start] - [Turn Off Computer].

NOTE

From the keyboard,

You may choose to press down on , then select the menu with  or .

3 Confirm shut down

Windows 2000

Select [Shut down], then select [OK].

Windows XP

Select [Turn Off].

Your computer will power off automatically.

CAUTION

Windows XP

When [Other people are logged on to this computer. Shutting down Windows might cause them to lose data] is displayed, select [No]. Shut down the computer only after all other users have logged off.

● Restarting your computer (without shutting down)

Windows 2000

Select [Restart], then select [OK].

Windows XP

Select [Restart].

NOTE

To quickly resume computer operation after shutting down,

The standby or hibernation function is available. ( Reference Manual “Standby/Hibernation Functions”)

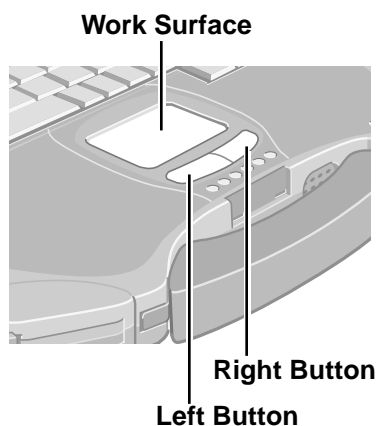

Touch Pad (Basic Operation)



Use the touch pad to move the cursor on the display and perform normal computer operations. For instructions on how to operate, refer to ^{Reference Manual} "Touch Pad (Advanced)".

NOTE

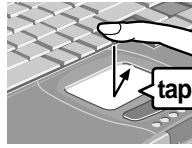
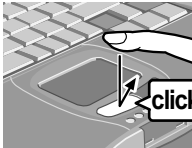
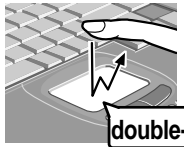
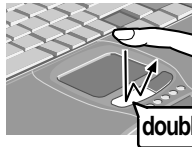
The touch pad has been designed to work only when a finger is used. Therefore, do not use other implement on the touch pad.

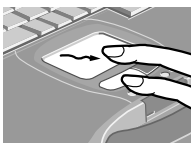
Function	Touch Pad Operation
Moving the Cursor	 Move the tip of your finger lightly over the surface.
Tapping/Clicking	 tapping or  clicking
Double-Tapping/Double-Clicking	 double-tapping or  double-clicking
Dragging	 or  While holding down the button, moving your finger on the work surface.

Handling the Touch Pad

- If a key combination such as **(Fn) + (F5)** is used while the pad is being touched, the function of the key combination will not work. In addition, it is possible that control of the cursor will be lost and the cursor will not show proper movements. In such cases, the computer has to be restarted by using the keyboard (e.g., ).
- Do not place any object on the work surface or press down forcefully with sharp-pointed objects (e.g., nails), hard objects that can leave marks (e.g., pencils and ball point pen).
- Do not allow things that could dirty the touch pad, such as oil. The cursor may not work properly in such cases.
- When the touch pad becomes dirty:
Wipe to remove dirty areas by using a dry soft cloth such as gauze or a soft cloth first applied with detergent diluted with water and then thoroughly wrung.
Do not use benzene, thinner, or disinfectant-type alcohol.

Reference Manual

The Reference Manual can be accessed on your computer. When a printer is connected, the Reference Manual can also be printed. This manual explains functions for you to make greater use of the computer, such as how to add peripheral devices, how the Setup Utility works and other useful information.

Run the Reference Manual

1 Turn your computer on

2 **Windows 2000**

Select [Reference Manual] in [Start] - [Programs] - [Panasonic] - [On-Line Manuals]

Windows XP

Select [Reference Manual] in [Start] - [All Programs] - [Panasonic] - [On-Line Manuals]

When the Reference Manual is started up for the first time, the License Agreement of the Acrobat Reader will be displayed. After reading the agreement, select [Accept] to access the Reference Manual.

Display the page
Go forward or backward a page, or to the beginning or end of a document.

Perform a "Find" operation

Cancel or correct an operation

Hand tool
To move around the current page.

Zoom-in

Change the display size
You can select to magnify/de-magnify the display.

Exit

Table of Content (Items)
By clicking an item, the corresponding page will be displayed at 100%.

Movable splitter bar
This bar can be dragged, for example, to the right to enlarge the display of the Table of Contents.

Page indicator
A desired page can be displayed by inputting the page number after clicking here.

(The display may be changed without notification.)

NOTE

- Illustrations may be difficult to view depending on the magnification. If this is the case, we recommend that the display be magnified.
 - The characters in PDF files (such as the Reference Manual) may be difficult to read depending on the Acrobat Reader settings and the Windows Desktop settings. In such cases, change the Acrobat Reader settings with the following procedure.
 - 1 Start up Acrobat Reader.
 - 2 Select [Edit] - [Preferences] - [Accessibility] and then set [Color Scheme] to [Use colors specified in document], then select [OK].
 - When the taskbar is hidden at the bottom portion of Acrobat® Reader, set the maximum display window size.
 - If a printer is connected, we recommend printing pages. The illustrations and display samples may not print with a high quality.
- Windows XP**
- When switching to a different user with the Fast User Switching function, PDF files may not be printed properly. In this case, log on with the administrator authority again, not using the Fast User Switching function, and try the operation once more.

List of Error Codes

The following is a list of the messages that BIOS can display. Most of them occur during POST. Some of them display information about a hardware device, e.g., the amount of memory installed. Others may indicate a problem with a device, such as the way it has been configured. Following the list are explanations of the messages and remedies for reported problems.

If your system displays one of except the messages marked below with an asterisk (*), write down the message and contact Panasonic Technical Support. If your system fails after you make changes in the Setup menus, reset the computer, enter Setup and install Setup defaults or correct the error.

0200 Failure Fixed Disk

Fixed disk in not working or not configured properly. Check to see if fixed disk is attached properly. Run Setup. Find out if the fixed-disk type is correctly identified.

0210 Stuck key

Stuck key on keyboard.

0211 Keyboard error

Keyboard not working.

0212 Keyboard Controller Failed

Keyboard controller failed test. May require replacing keyboard controller.

0213 Keyboard locked - Unlock key switch

Unlock the system to proceed.

0230 System RAM Failed at offset : *nnnn*

System RAM failed at offset *nnnn* of in the 64k block at which the error was detected.

0231 Shadow RAM Failed at offset : *nnnn*

Shadow RAM failed at offset *nnnn* of the 64k block at which the error was detected.

0232 Extended RAM Failed at offset : *nnnn*

Extended memory not working or not configured properly at offset *nnnn*.

0250 System battery is dead - Replace and run SETUP

The CMOS clock battery indicator shows the battery is dead. Replace the battery and run Setup to reconfigure the system.

***0251 System CMOS checksum bad - Default configuration used**

System CMOS has been corrupted or modified incorrectly, perhaps by an application program that changes data stored in CMOS. The BIOS installed Default SETUP Values. If you do not want these values, enter Setup and enter your own values. If the error persists, check the system battery or contact Panasonic Technical Support.

0260 System timer error

The timer test failed. Requires repair of system board.

0270 Real time clock error

Real-time clock fails BIOS test. May require board repair.

***0280 Previous boot incomplete - Default configuration used**

Previous POST did not complete successfully. POST loads default values and offers to run Setup. If the failure was caused by incorrect values and they are not corrected, the next boot will likely fail. On systems with control of **wait states**, improper Setup settings can also terminate POST and cause this error on the next boot. Run Setup and verify that the wait-state configuration is correct. This error is cleared the next time the system is booted.

0281 Memory Size found by POST differed from EISA CMOS

Memory size found by POST differed from EISA CMOS.

02B0 Diskette drive A error

02B1 Diskette drive B error

Drive A: or B: is present but fails the BIOS POST diskette tests. Check to see that the drive is defined with the proper diskette type in Setup and that the diskette drive is attached correctly.

02B2 Incorrect Drive A type - run SETUP

Type of floppy drive A: not correctly identified in Setup.

02B3 Incorrect Drive B type - run SETUP

Type of floppy drive B: not correctly identified in Setup.

02D0 System cache error - Cache disabled

Contact Panasonic Technical Support.

02F0: CPU ID:

CPU socket number for Multi-Processor error.

02F4: EISA CMOS not writable

ServerBIOS2 test error: Cannot write to EISA CMOS.

List of Error Codes

02F5: DMA Test Failed

ServerBIOS2 test error: Cannot write to extended DMA (Direct Memory Access) registers.

02F6: Software NMI Failed

ServerBIOS2 test error: Cannot generate software NMI (Non-Maskable Interrupt).

02F7: Fail - Safe Timer NMI Failed

ServerBIOS2 test error: Fail-Safe Timer takes too long.

***device* address Conflict**

Address conflict for specified *device*.

Allocation Error for: *device*

Run ISA or EISA Configuration Utility to resolve resource conflict for the specified *device*.

Failing Bits : *nnnn*

The hex number *nnnn* is a map of the bits at the RAM address which failed the memory test. Each 1 (one) in the map indicates a failed bit. See error 230,231 or 232 for offset address of the failure in System, Extended or Shadow memory.

Invalid System Configuration Data

Problem with NVRAM (CMOS) data.

I/O device IRQ conflict

I/O device IRQ conflict error.

Operating System not found

Operating system cannot be located on either drive A: or drive C:. Enter Setup and see if fixed disk and drive A: are properly identified.

Parity Check 1 *nnnn*

Parity error found in the system bus. BIOS attempts to locate the address and display it on the screen. If it cannot locate the address, it displays ????. Parity is a method for checking errors in binary data. A parity error indicates that some data has been corrupted.

Parity Check 2 *nnnn*

Parity error found in the I/O bus. BIOS attempts to locate the address and display it on the screen. If it cannot locate the address, it displays ????.







Press <F1> to resume, <F2> to Setup

Displayed after any recoverable error message. Press <F1> to start the boot process or <F2> to enter a Setup and change the settings. Write down and follow the information shown on the screen.

Dealing with Problems (Summary)

When a problem occurs, refer to this page. The "Reference Manual" also contains detailed information. If a problem appears to be related to a software application, read the software related manual. If you still cannot troubleshoot the problem, contact Panasonic Technical Support.

Starting Up

<p>The power indicator or battery indicator is not lit</p>	<ul style="list-style-type: none"> ● Check the cable connection for the AC adaptor. ● Check to see if a fully charged battery is properly installed. ● Remove the battery pack and disconnect the AC adaptor, then connect them again.
<p> is displayed</p>	<p>Input your password. If you have forgotten it, contact Panasonic Technical Support.</p>
<p>POST Startup Error(s) is displayed</p>	<p> page 19</p>
<p>Windows startup, or an operation is extremely slow</p>	<p>Press (F9) in the Setup Utility ( <small>Reference Manual</small> "Setup Utility"). This will restore the Setup Utility's settings to their default values (except the password settings). Then, the Setup Utility must be run once again for you to input the appropriate operating environment settings. (The processing speed depends on the application software used, so this operation may not cause the processing speed to increase.)</p>
<p>The date and time are incorrect</p>	<ul style="list-style-type: none"> ● You can set the date and time using the following menu. Windows 2000 : [Control Panel] - [Date/Time] Windows XP : [Control Panel] - [Date, Time, Language, and Regional Options] - [Date and Time] ● When the computer is connected to a LAN, confirm the date and time of the server. ● If you continue to experience problems, the internal battery maintaining the clock may need to be replaced. Contact Panasonic Technical Support. ● This computer will not correctly recognize the date and time starting from the year 2100 A.D.
<p>When the previous item is not the cause</p>	<ul style="list-style-type: none"> ● Press (F9) in the Setup Utility ( <small>Reference Manual</small> "Setup Utility"). This will restore the Setup Utility's settings to their default values (except the password settings). ● Try removing all peripheral devices. ● Windows 2000 Click [Local Disk(C:)] in [My Computer] with the right button, select [Properties], then select [Tools] - [Check Now]. ● Windows XP Click [Local Disk(C:)] in [Start] - [My Computer] with the right button, select [Properties], then select [Tools] - [Check Now]. ● At start-up, press (F8) to operate the computer in the Safe mode.
<p>When resuming from the standby or hibernation mode,  does not appear even if a password has been set in the Setup Utility</p>	<p>Use the Windows password as follows:</p> <p>Windows 2000 Set the password in [Control Panel] - [Users and Passwords], then add the check mark for [Prompt for password when computer goes off standby] in [Control Panel] - [Power Options] - [Advanced].</p> <p>Windows XP Select the account to change in [Control Panel] - [User Accounts] and set the password, then add the check mark for [Prompt for password when computer resumes from standby] in [Control Panel] - [Performance and Maintenance] - [Power Options] - [Advanced].</p>
<p>When the administrator password is forgotten</p>	<p>Windows 2000 After reinstalling, setup Windows and then set the password again.</p> <p>Windows XP If you have created a password reset disk ( page 12), a message is displayed when you fail to correctly enter the password. Follow the message's instructions and set the password again by using the password reset disk. If you have not created a password reset disk, after reinstalling, setup Windows and then set the password again.</p>

Dealing with Problems (Summary)

● Display

<p>No display after powering on</p>	<ul style="list-style-type: none"> ● When there is no display to an external display, <ul style="list-style-type: none"> • Check your cable connection to the external display. • Confirm your display is powered on. • Check the settings for your external display. ● Try changing the display by pressing (Fn) + (F3). ● When displaying only through an external display, if the computer is shut down (including the standby or hibernation function), there will be no display on the LCD unless the external display is connected when the computer is powered on or operations are resumed. In this case, connect the external display or press (Fn) + (F3).
<p>The power has not been turned off, but after a certain period of time, there is no display</p>	<ul style="list-style-type: none"> ● Has the computer been set to the power-saving mode? To resume operation of your computer from the condition the power of the display is off (for energy conservation purposes), press any key unrelated to the direct triggering of a selection, like (Shift). ● To save power, your computer may have automatically entered either the standby or hibernation mode. (Reference Manual “Computing on the Road”) Rotate the power switch.
<p>The cursor cannot be controlled</p>	<p>Restart the computer by using the keyboard (e.g., (F12)).</p>
<p>An afterimage appears (e.g., green, red, and blue dots remain on the display) or there are dots not displaying the correct colors</p>	<ul style="list-style-type: none"> ● If an image is displayed for a prolonged period of time, an afterimage may appear. This is not a malfunction. The afterimage will disappear when a different screen is displayed. ● High-precision and advanced technologies are necessary in the production of color liquid crystal displays (color LCDs). Therefore, if 0.002% or less of the picture elements either fail to light or remain constantly lit (that is, more than 99.998% of elements are functioning properly), no defect is considered to exist.
<p>The external display no longer displays properly</p>	<p>When an external display not compatible with the power saving mode is used with the computer, the external display may no longer display properly when the computer enters the condition the power of the display is off (for energy conservation purposes). In such cases, turn off the power to the external display.</p>
<p>The screen becomes disordered</p>	<p>Changing the number of colors of the display may affect the screen. Restart the computer.</p>
<p>During simultaneous display*, the screen of the external display becomes disordered</p>	<ul style="list-style-type: none"> ● Try changing the display by pressing (Fn) + (F3). ● If you continue to experience problems, try changing the display in the following menu. Windows 2000 : [Start] - [Settings] - [Control Panel] - [Intel® Graphics Technology]. Windows XP : [Start] - [Control Panel] - [Appearance and Themes] - [Display] - [Settings] - [Advanced] - [Intel® Graphics Technology].
<p>When the setting of the screensaver is changed, an error may occur during a resume operation</p>	<p>When the computer enters the standby or hibernation mode while the screensaver is running, an error may occur during a resume operation. In such cases, turn off the screensaver or try changing the pattern of the screensaver.</p>

* To display the same screen on both the internal LCD and external display:
 Simultaneous display = Intel (R) Dual Display clone in [Intel (R) 830M Graphics Controller Properties]

● Battery Indicator

The red indicator lights. Repeated beeping sound while the computer is in use.	The battery level is low. Save your data and power off your computer. After connecting the AC adaptor or replacing the battery pack with a fully charged one, turn your computer on.
The red indicator blinks	<ul style="list-style-type: none"> ● The battery pack or recharging function may be defective. Quickly remove the battery pack and disconnect the AC adaptor, then connect them again. ● If the problem persists, contact Panasonic Technical Support.
The orange indicator blinks	Unable to charge because of an improper temperature range. (☞ page 6)

● Reference Manual

The Reference Manual is not displayed	Is Acrobat Reader installed? If Acrobat Reader is not installed, run [c:\util\reader\ar500enu.exe] in [Start] - [Run] to reinstall the program. When installing the program, do not change the installation destination folder. If the destination folder is changed, the Reference Manual cannot be opened from the [Start] menu.
--	---

● Shutting down

Windows cannot be shut down or restarted	<ul style="list-style-type: none"> ● Do not shut down Windows during music playback. ● If a USB device is connected, try removing it. ● Was an attempt made to shut down (or restart) Windows while the computer was connected to a network drive using a LAN? With the following procedure, shut down (or restart) Windows after disconnecting the network drive. <p>1 Windows 2000 Select [My Computer] on the Desktop with the right button of the touch pad and then select [Disconnect Network Drive].</p> <p>Windows XP Select [Start] - [My Computer] and then select [Tools] - [Disconnect Network Drive].</p> <p>2 Select all of the displayed network drives, then select [OK].</p>
---	--

● Others

Computer hangs	<ul style="list-style-type: none"> ● Press Ctrl + Alt + Del and turn off the computer. ● After shutting down by rotating the power switch for more than four seconds, rotate the power switch to power on and open the application again. If the program no longer works normally, delete the program using the following menu. Then reinstall the program. <p>Windows 2000 : [Control Panel] - [Add/Remove Programs] Windows XP : [Control Panel] - [Add or Remove Programs]</p>
-----------------------	--

● Fast User Switching function **Windows XP**

Some applications may not work properly	<p>When switching to a different user with the Fast User Switching function, the following problems may occur.</p> <ul style="list-style-type: none"> • Some applications may not work properly (for example, PDF files may not be printed properly). • Key combinations with the Fn key may not work. • It may not be possible to set the settings of the display. <p>If any of the above occur, log on with the administrator authority again, not using the Fast User Switching function, and try the operation once more.</p>
--	--

Reinstalling Software

Before Reinstallation

● Preparing

- You will need the followings:
 - Product Recovery CD-ROM
 - If it was necessary to create BACKUP DISKS (☞ page 13), you will need the BACKUP DISKS (e.g., FIRSAID FD) and the floppy disk drive.
 - The optional CD drive (Confirm the latest information on optional products in catalogs, etc.)
Mount the CD drive in the multimedia pocket. (Refer to the Operating Instructions of the CD drive for details.)
- The operation of reinstallation takes about 20 - 30 minutes.

● Important

- Save all important data. If reinstallation is carried out, all data existing prior to the installation will be lost. The reinstallation will return the computer to close to the conditions at time of purchase.
- Before the reinstallation procedure, remove all peripherals (except for the CD drive and the floppy disk drive).
- Be sure the AC adaptor is connected until the reinstallation procedure is completed.

Reinstalling

CAUTION

- If data on your hard disk is compressed, the data should be uncompressed.
- Be sure not to be a disk in CD drive.

- 1 Turn the computer off and set the optional CD drive in the multimedia pocket, and then turn the computer on.
- 2 When the message [Press F2 to enter SETUP] is displayed, press **(F2)** and then run the Setup Utility.
If the password has been set, enter the Supervisor Password.
- 3 Write down all of the contents of the Setup Utility and then press **(F9)**.
At the confirmation message, select [Yes] and press **(Enter)**.
- 4 Select [Boot] menu, press **(↑)** / **(↓)** and **(F5)** / **(F6)** until [CD Drive] is at the top of the [Boot] menu and [Floppy Drive] is the next position.
- 5 Set the Product Recovery CD-ROM1 in the CD drive.
- 6 Press **(F10)**.
At the confirmation message, select [Yes] and then press **(Enter)**. The computer will reboot, and the License Agreement screen should appear. Select [1. Yes, I agree to the provisions above and wish to continue!].
- 7 At the screen for the selection of the Operating System, select either Windows 2000 or Windows XP.
You can reinstall only the initially selected Operating System.

- 8 This screen should appear.

Windows 2000

Select a number

1. Restore the whole HDD to factory default
2. Restore Windows(R) 2000 Professional to the first partition
3. End

Windows XP

Select a number

1. Restore the whole HDD to factory default
2. Restore Windows(R) XP Professional to the first partition
3. End

- 9 Make a selection from the menu.

To restore all contents of the hard disk to factory default, including the partition setting(s):

Select [1. Restore the whole HDD to factory default].

To reinstall Windows 2000/Windows XP to the first partition to factory default:

Select [2. Restore Windows(R) 2000 Professional (or Windows(R) XP Professional) to the first partition].

In such cases, the initial partition size must be 4GB or more of the hard disk size. Reinstallation cannot be performed with a small partition size.

NOTE

If "The program has detected an error 110 on the partition starting at sector xxxxxxxx on disk1." is displayed, select [Yes].

- 10** At the confirmation message, press **(Y)**.
The operation of reinstallation for the hard disk starts automatically.
When the message “insert the next CD” is displayed, insert the Product Recovery CD-ROM showing the next number in the sequence, and then select **[OK]**.
(In the case of Windows 2000, only Product Recovery CD-ROMs 1 to 3 can be used.)

NOTE

If **[OK]** is not immediately selected:
The message “The media does not contain the correct file” may appear. When **[OK]** is selected, the message “insert the next CD” will be displayed again.
Confirm that the proper Product Recovery CD-ROM has been inserted by opening the tray of the CD drive and then close the tray, then immediately select **[OK]**.

- 11** After the reinstallation procedure completes, the following message will appear on the display. Remove the floppy disk or Product Recovery CD-ROM, then restart the computer by pressing **(Ctrl) + (Alt) + (Del)**.

Windows 2000

Windows(R) 2000 Professional install wizard will start after reboot.
Restore process will execute more after Windows(R) 2000 Professional install wizard.
Restart the computer after removing Product Recovery CD-ROM.

Windows XP

Windows(R) XP Professional install wizard will start after reboot.
Restore process will execute more after Windows(R) XP Professional install wizard.
Restart the computer after removing Product Recovery CD-ROM.

- 12** When the message **[Press F2 to enter SETUP]** is displayed, press **(F2)** and then run the Setup Utility.
If the password has been set, enter the Supervisor Password.

- 13** Press **(F9)**.
At the confirmation message, select **[Yes]** and press **(Enter)**. (The Setup Utility settings will return to their default values. Even the security settings with the exception of the password(s) will return to their default values.)

NOTE

If there are added functions that are not listed in the Specifications of this Operating Instructions, we recommend disabling their device settings. If the settings are enabled, additional operations may be necessary during the Windows setup procedure. (We also recommend referring to the Supplementary Instructions, if they are included with the computer.)

- 14** Using either **(→)** or **(←)**, select **[Exit]** and then select **[Save Current Values]**, then press **(Enter)**.
At the confirmation message, select **[Yes]** and press **(Enter)**.

- 15** Turn the computer off, and then turn the computer on.

- 16** Perform the setup procedure for Windows by following the instructions on the screen.
(Refer to the Supplementary Instructions, if they are included with the computer.)

Windows 2000  Page 11
Windows XP  page 12

- 17** Run the Setup Utility and change the settings where necessary.

NOTE

- When the message **[Operating System not found]** is displayed, press **(Ctrl) + (Alt) + (Del)** and perform the operations from Step **12** to Step **15**.
- If you fail to press **(F2)** in Step **12**, restart the computer and perform the operations from Step **12** to Step **15** after finishing Windows setup procedure.

LIMITED USE LICENSE AGREEMENT

THE SOFTWARE PROGRAM(S) ("PROGRAMS") FURNISHED WITH THIS PANASONIC® PRODUCT ("PRODUCT") ARE LICENSED ONLY TO THE END-USER ("YOU"), AND MAY BE USED BY YOU ONLY IN ACCORDANCE WITH THE LICENSE TERMS DESCRIBED BELOW. YOUR USE OF THE PROGRAMS SHALL BE CONCLUSIVELY DEEMED TO CONSTITUTE YOUR ACCEPTANCE OF THE TERMS OF THIS LICENSE.

Matsushita Electric Industrial Co., Ltd. ("MEI") has developed or otherwise obtained the Programs and hereby licenses their use to you. You assume sole responsibility for the selection of the Product (including the associated Programs) to achieve your intended results, and for the installation, use and results obtained therefrom.

LICENSE

- A. MEI hereby grants you a personal, non-transferable and non-exclusive right and license to use the Programs in accordance with the terms and conditions stated in this Agreement. You acknowledge that you are receiving only a LIMITED LICENSE TO USE the Programs and related documentation and that you shall obtain no title, ownership nor any other rights in or to the Programs and related documentation nor in or to the algorithms, concepts, designs and ideas represented by or incorporated in the Programs and related documentation, all of which title, ownership and rights shall remain with MEI or its suppliers.
- B. You may use the Programs only on the single Product which was accompanied by the Programs.
- C. You and your employees and agents are required to protect the confidentiality of the Programs. You may not distribute or otherwise make the Programs or related documentation available to any third party, by time-sharing or otherwise, without the prior written consent of MEI.
- D. You may not copy or reproduce, or permit to be copied or reproduced, the Programs or related documentation for any purpose, except that you may make one (1) copy of the Programs for backup purposes only in support of your use of the Programs on the single Product which was accompanied by the Programs. You shall not modify, or attempt to modify, the Programs.
- E. You may transfer the Programs and license them to another party only in connection with your transfer of the single Product which was accompanied by the Programs to such other party. At the time of such a transfer, you must also transfer all copies, whether in printed or machine readable form, of every Program, and the related documentation, to the same party or destroy any such copies not so transferred.
- F. You may not remove any copyright, trademark or other notice or product identification from the Programs and you must reproduce and include any such notice or product identification on any copy of any Program.

YOU MAY NOT REVERSE ASSEMBLE, REVERSE COMPILE, OR MECHANICALLY OR ELECTRONICALLY TRACE THE PROGRAMS, OR ANY COPY THEREOF, IN WHOLE OR IN PART.

YOU MAY NOT USE, COPY, MODIFY, ALTER, OR TRANSFER THE PROGRAMS OR ANY COPY THEREOF, IN WHOLE OR IN PART, EXCEPT AS EXPRESSLY PROVIDED IN THE LICENSE.

IF YOU TRANSFER POSSESSION OF ANY COPY OF ANY PROGRAM TO ANOTHER PARTY, EXCEPT AS PERMITTED IN PARAGRAPH E ABOVE, YOUR LICENSE IS AUTOMATICALLY TERMINATED.

TERM

This license is effective only for so long as you own or lease the Product, unless earlier terminated. You may terminate this license at any time by destroying, at your expense, the Programs and related documentation together with all copies thereof in any form. This license will also terminate effective immediately upon occurrence of the conditions therefore set forth elsewhere in this Agreement, or if you fail to comply with any term or condition contained herein. Upon any such termination, you agree to destroy, at your expense, the Programs and related documentation together with all copies thereof in any form.

YOU ACKNOWLEDGE THAT YOU HAVE READ THIS AGREEMENT, UNDERSTAND IT AND AGREE TO BE BOUND BY ITS TERMS AND CONDITIONS. YOU FURTHER AGREE THAT IT IS THE COMPLETE AND EXCLUSIVE STATEMENT OF THE AGREEMENT BETWEEN US, WHICH SUPERSEDES ANY PROPOSAL OR PRIOR AGREEMENT, ORAL OR WRITTEN, AND ANY OTHER COMMUNICATIONS BETWEEN US, RELATING TO THE SUBJECT MATTER OF THIS AGREEMENT.

Contrat de licence d'usage limité

Le(s) logiciel(s) (les "Logiciels") fournis avec ce produit Panasonic® (le "Produit") sont exclusivement concédés en licence à l'utilisateur ultime ("vous"), et ils ne peuvent être utilisés que conformément aux clauses contractuelles ci-dessous. En utilisant les logiciels, vous vous engagez de manière définitive à respecter les termes, clauses et conditions des présentes.

Matsushita Electric Industrial Co., Ltd. ("MEI") a mis au point ou obtenu les Logiciels et vous en concède l'utilisation par les présentes. Vous assumez l'entière responsabilité du choix de ce Produit (y compris des Logiciels associés) pour obtenir les résultats escomptés, ainsi que de l'installation, de l'utilisation et des résultats obtenus.

Licence

- A. MEI vous octroie par les présentes le droit et la licence personnels, non cessibles et non exclusifs d'utiliser les Logiciels conformément aux termes, clauses et conditions de ce contrat. Vous reconnaissez ne recevoir qu'un droit limité d'utiliser les Logiciels et la documentation les accompagnant et vous vous engagez à n'obtenir aucun droit de titre, propriété ni aucun autre droit vis-à-vis des Logiciels et de la documentation les accompagnant ni vis-à-vis des algorithmes, concepts, dessins, configurations et idées représentés par ou incorporés dans les Logiciels et la documentation les accompagnant, dont les titres, la propriété et les droits resteront tous à MEI ou à leurs propriétaires.
- B. Vous ne pouvez utiliser les Logiciels que sur le Produit unique qui est accompagné par les Logiciels.
- C. Vous et vos employés ou agents êtes requis de protéger la confidentialité des Logiciels. Vous ne pouvez ni distribuer ni mettre les Logiciels et la documentation les accompagnant à la disposition d'un tiers, par partage de temps ou de quelque autre manière que ce soit, sans l'autorisation écrite préalable de MEI.
- D. Vous ne pouvez ni copier ni reproduire ni permettre la copie ni la reproduction des Logiciels ni de la documentation les accompagnant pour quelque fin que ce soit, à l'exception d'une (1) copie des Logiciels à des fins de sauvegarde uniquement pour soutenir votre utilisation des Logiciels sur le Produit unique qui est accompagné par les Logiciels. Vous ne pouvez ni modifier ni tenter de modifier les Logiciels.
- E. Vous ne pouvez céder les Logiciels et en octroyer la licence à une autre partie qu'en rapport avec votre cession du Produit unique qui est accompagné par les Logiciels à cette autre partie. Au moment de cette cession, vous devez céder également toutes les copies, que ce soit sous forme imprimée ou lisible par la machine, de tous les Logiciels ainsi que de la documentation les accompagnant, à la même partie ou détruire les copies non cédées.
- F. Vous ne pouvez retirer aucune marque de droits d'auteur, marque de commerce ou autre ni aucune identification de produit des Logiciels et vous devez reproduire et inclure toutes ces notices ou identifications de produit sur toutes les copies des Logiciels.

Vous ne pouvez assembler en sens inverse, compiler en sens inverse ni retracer les Logiciels ni aucune de leurs copies, de façon électronique ou mécanique, en tout ou en partie.

Vous ne pouvez utiliser, copier, modifier, altérer ni céder les Logiciels ni aucune de leurs copies, en tout ou en partie, à l'exception de ce qui est expressément stipulé dans ce contrat.

Si vous cédez la possession de toute copie ou de tout Logiciel à une autre partie, à l'exception de ce qui est autorisé au paragraphe E ci-dessus, votre licence est automatiquement résiliée.

Termes, clauses et conditions

Cette licence n'est effective que pour la durée de possession ou de crédit-bail du Produit, à moins d'une résiliation antérieure. Vous pouvez résilier cette licence à tout moment en détruisant, à vos frais, les Logiciels et la documentation les accompagnant avec toutes leurs copies, sous quelque forme que ce soit. Cette licence sera également résiliée, avec application immédiate, si les conditions de résiliation définies ailleurs dans ce contrat se sont réalisées ou si vous ne respectez pas les termes, clauses et conditions qui y sont contenues. Au moment de la résiliation, vous acceptez de détruire, à vos frais, les Logiciels et la documentation les accompagnant avec toutes leurs copies, sous quelque forme que ce soit.

Vous reconnaissez avoir lu ce contrat, en avoir compris toute la substance et avoir accepté de respecter ses termes, clauses et conditions. Vous reconnaissez en outre qu'ils sont la description complète et exclusive du contrat conclu entre nous, contrat qui remplace et annule toute proposition ou contrat précédent, écrit ou oral, et toute autre communication entre nous, relativement à l'objet du présent contrat.

Names and Functions of Parts

The illustrations shown may differ from the actual physical appearances.

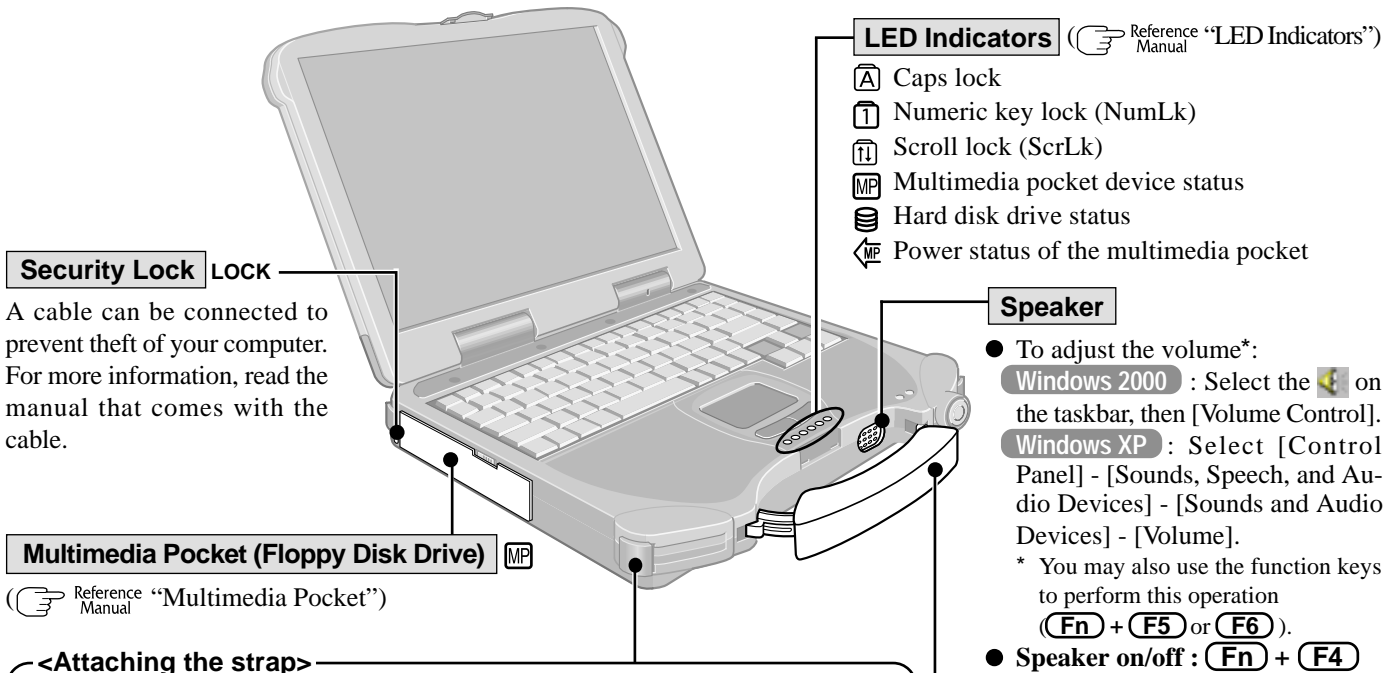
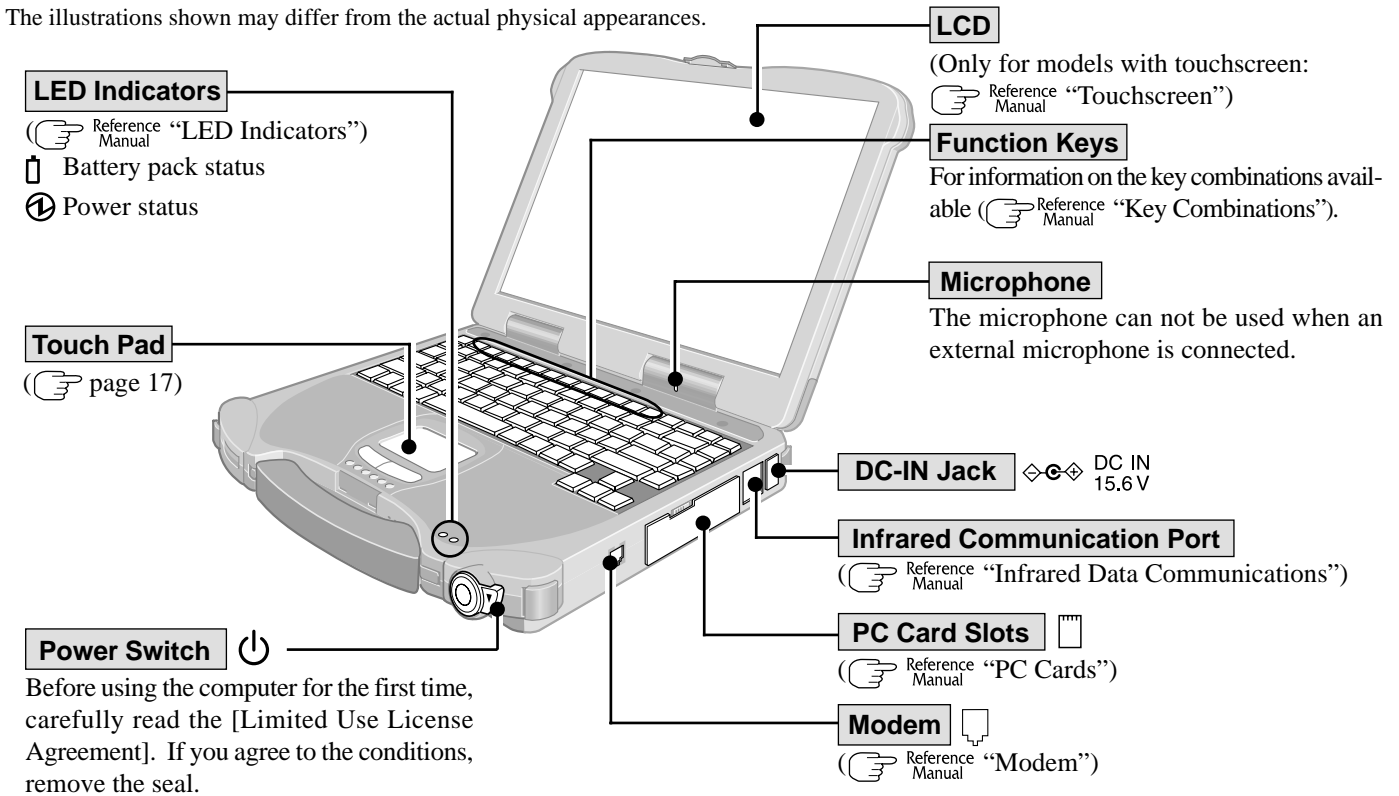

<Attaching the strap>

CAUTION

- The strap has been designed to carry only the weight of the computer. Therefore, be sure that the strap does not carry a weight that exceeds the weight of the computer. The strap may accidentally come loose from the computer.
- Do not use a strap that is damaged or about to tear.

Carrying Handle
 For enhanced portability and in-the-field efficiency.

Microphone Jack



Use only a monaural condenser microphone.
Using an input source other than a monaural condenser microphone may not allow audio to be input or may damage the equipment.
The settings for [Internal MIC] of the [Main] menu in the Setup Utility apply to both the Internal Microphone and the Microphone Jack.

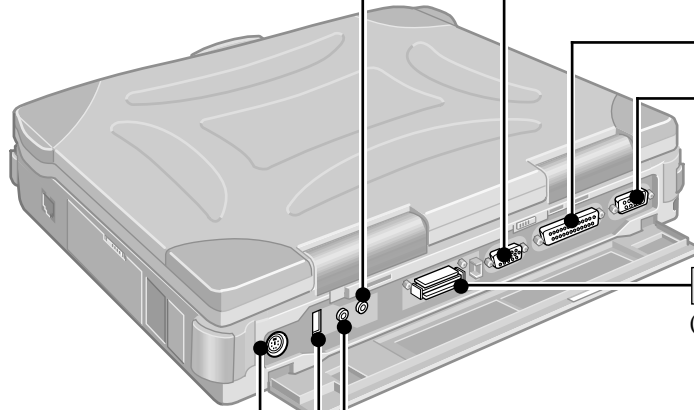

External Display Port



Parallel Port



Serial Port



Expansion Bus Connector



Reference Manual "Port Replicator"

External Keyboard/Mouse Port



USB Port



Reference Manual "USB Device"

Headphone Jack



Use this connector to connect headphones or amplifier-equipped speakers. Audio output from the internal speaker is disabled when headphones or external speakers are connected.

NOTE

When using a microphone (internal or external), do not remove the check mark for "Mute" under "Microphone Balance" of the Volume Control dialog box and do not increase the playback volume. Howling may result. Howling may occur in the same way when disconnecting an external microphone. (The microphone of "Volume Control" is in the state of mute at the time of factory shipment. This is not shown at the time of factory shipment.)

MP Release Lever

Reference Manual "Multimedia Pocket"

Battery Pack

Reference Manual "Battery Power"

Hard Disk Drive

Reference Manual "Hard Disk Drive"

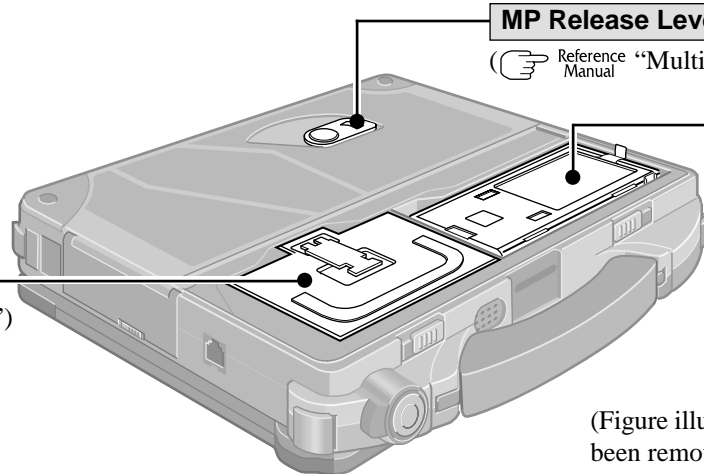

(Figure illustrating when the covers have been removed.)



A lithium ion battery that is recyclable powers the product you have purchased. Please call 1-800-8-BATTERY for information on how to recycle this battery.

L'appareil que vous vous êtes procuré est alimenté par une batterie au lithium-ion. Pour des renseignements sur le recyclage de la batterie, veuillez composer le 1-800-8-BATTERY.

Specifications

● Main Specifications

Model No.		CF-28STJAZDM/KM	CF-28SRJAZDM/KM	
CPU		Mobile Intel® Pentium® III Processor-M 1 GHz featuring Intel® SpeedStep™ technology L1 Cache Memory: 32 KB L2 (Second) Cache Memory: 512 KB		
Memory (Expandable to)		256 MB (512 MB Max.)		
Video Memory		UMA (32 MB Max.)		
LCD	Type	13.3 type (TFT) with Touchscreen	12.1 type (TFT)(Transflective*) with Touchscreen	
	Displayed Colors*1	256/65536/16M colors (640 x 480 dots/800 x 600 dots/1024 x 768 dots)	256/65536/16M colors (640 x 480 dots/800 x 600 dots)	
External Display		256/65536/16M colors (640 x 480 dots/800 x 600 dots/1024 x 768 dots/1280 x 1024 dots)*3		
Hard Disk Drive		30 GB*4		
Keyboard		87 keys		
Floppy Disk Drive		720 KB/1.44 MB (two-mode)		
Slots	PC Card Slots	Two Type I or Type II, or one Type III		
	Allowable current (total for two slots)	3.3 V: 400 mA 5 V: 400 mA		
	RAM Module Slot*5	144-pin, 3.3-V, SO-DIMM, SDRAM, PC133 Compliant		
Interface	Parallel Port	Dsub 25-pin female		
	External Display Port	Mini Dsub 15-pin female		
	Serial Port	Dsub 9-pin male		
	Microphone Jack*6	Miniature jack, 3.5 DIA		
	Headphone Jack	Miniature jack, 3.5 DIA, Impedance 32 Ω, Output Power 4 mW x 2		
	Infrared Communication Port	IrDA 1.1 compliant, 4 Mbps data transmission speed*7		
	External Keyboard/Mouse Port	Mini DIN 6-pin female		
	Expansion Bus Connector	Dedicated 80-pin female		
	USB Port	4-pin		
	Modem	RJ-11 jack, Data: 56 kbps (V.90 & K56flex) FAX:14.4 kbps		
Pointing Device		Touch Pad, Touchscreen (Anti-Reflection, Stylus (included) touch capable)		
Microphone		Monaural Microphone (built in)		
Speaker		Monaural Speaker (built in)		
Sound		WAVE and MIDI playback		
Battery Pack		Li-ion 11.1 V, 5.4 Ah		
	Operating Time*8	Main battery: Approx. 3.5 hours - 5.5 hours Main battery + Second battery: Approx. 6.5 hours - 10 hours		
		Charging Time*8	Power On	Main battery: Approx. 5.5 hours Main battery + Second battery: Approx. 9.5 hours
	Power Off		Main battery: Approx. 3 hours Main battery + Second battery: Approx. 5.5 hours	
	Clock Battery		Coin type lithium battery 3.0 V	
AC Adaptor*9	Input	100 V - 240 V AC, 50 Hz/60 Hz		
	Output	15.6 V DC, 5.0 A		
Power Consumption*10		Approx. 35 W*11 / Approx. 55 W (maximum when recharging in the ON state)		

*1 A 16M color display is achieved by using the dithering function. **Windows XP** : A 256 color and 640x480 dots are not supported.

*2 The TransflectiveLCD improves display under strong light by using the reflection of light as illumination in addition to the same backlight illumination as a general LCD.
The light sensor works to sense strong light so that the TransflectiveLCD will not require backlight illumination, and to power off the backlight illumination to conserve energy.

*3 Maximum resolution depends on the specifications of the external display. **Windows XP** : A 256 color and 640x480 dots are not supported.

*4 1GB = 10⁹ bytes

*5 Only a RAM card designed for PC133 can be added.

*6 Use only a monaural condenser microphone.

*7 Separate communications software is necessary.

The infrared data communications can not be used at 4 Mbps data transfer speed.

*8 Varies depending on the usage conditions, CPU speed, etc.

*9 The AC adaptor is compatible with power sources up to 240 V AC adaptor. This computer is supplied with a 125 V AC compatible AC cord.

*10 Approx. 0.9 W when the battery pack is fully charged (or not being charged) and the computer is off.

*11 Rated power consumption.

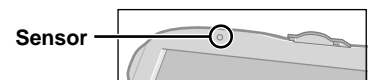

● Main Specifications

Model No.		CF-28STJAZDM/KM	CF-28SRJAZDM/KM
Environment	In use	Temperature	5 °C to 35°C {41 °F to 95 °F}
		Humidity	30% to 80% RH (No condensation)
	Not in use	Temperature	-20 °C to 60 °C {-4 °F to 140 °F}
		Humidity	30% to 90% RH (No condensation)
Physical Dimensions (W x H x D)		302 mm x 63.5 mm(at the rear)/65.5 mm(at the front) x 275 mm {11.9 " x 2.5 "/2.6 " x 10.8 "} (excluding protrusion)	
Weight (including the carrying handle)		Approx. 4.2 kg {Approx. 9.3 lb.}	Approx. 4.1 kg {Approx. 9.0 lb.}

● Software

Model No.	CF-28STJAZDM/KM	CF-28SRJAZDM/KM
Operating System	Microsoft® Windows® 2000 Professional with Service Pack2* (DM) / Microsoft® Windows® XP Professional* (KM) (NTFS File System)	
Utility Programs	Setup Utility DMI Viewer Adobe® Acrobat® Reader 5.0	

- * • The set-up utilities for both Windows® 2000 and Windows® XP operating systems are preinstalled on this system.
 • When the system is initially started, you have the option of selecting operating system of your choice.
 • Any operating system that was not selected initially will be deleted automatically.

LIMITED WARRANTY

For U.S.A.

PANASONIC PERSONAL COMPUTER AND PERIPHERALS LIMITED WARRANTY

Panasonic Computer Solution Company (referred to as "Panasonic") will repair this product (other than software, which is covered by a separate warranty) with new or rebuilt parts, free of charge in the U.S.A. for three (3) years from the date of original purchase in the event of a defect in materials or workmanship. This warranty includes the AC adaptor but excludes the batteries and all other options and accessories which are covered for a period of one (1) year from the date of purchase.

This warranty is extended solely to the original purchaser. A purchase receipt or other proof of date of original purchase will be required before warranty performance is rendered.

This warranty only covers failures due to defects in materials or workmanship which occur during normal use. It does not cover damage which occurs in shipment or failures which are caused by products not supplied by Panasonic, or failures which result from alteration, accident, misuse, introduction of liquid or other foreign matter into the unit, abuse, neglect, installation, maladjustment of consumer controls, improper maintenance, modification or service by anyone other than a Factory Service Center or authorized Panasonic Service Dealer, or damage that is attributable to acts of God.

Limits and Exclusions:

There are no other express warranties except as listed below.

PANASONIC SHALL NOT BE LIABLE FOR LOSS OF DATA OR OTHER INCIDENTAL OR CONSEQUENTIAL DAMAGES RESULTING FROM THE USE OF THIS PRODUCT, OR ARISING OUT OF ANY BREACH OF THIS WARRANTY. ALL EXPRESS AND IMPLIED WARRANTIES, INCLUDING THE WARRANTIES OF MERCHANTABILITY AND FITNESS FOR A PARTICULAR PURPOSE ARE LIMITED TO THE APPLICABLE WARRANTY PERIOD SET FORTH ABOVE. Some states do not allow the exclusion or limitation of incidental or consequential damages, or limitations on how long an implied warranty lasts, so the above limitations or exclusions may not apply to you.

This limited warranty gives you specific legal rights, and you may also have other rights which vary from state to state. If a problem with your product develops during or after the warranty period, you may contact our representatives at 1-800-LAPTOP5. If the problem is not handled to your satisfaction, then write to the Consumer Affairs Division at the address indicated below.

SOFTWARE LIMITED WARRANTY

Panasonic Computer Solution Company (referred to as "Panasonic") warrants to you only that the disk(s) or other media on which the Programs are furnished will be free from defects in materials and workmanship under normal use for a period of sixty (60) days from the date of delivery thereof to you, as evidenced by your purchase receipt.

This is the only warranty Panasonic makes to you. Panasonic does not warrant that the functions contained in the Programs will meet your requirements or that the operation of the Programs will be uninterrupted or error free.

Panasonic's entire liability, and your exclusive remedy under this warranty shall be limited to the replacement, in the United States, of any defective disk or other media which is returned to Panasonic's Authorized Service Center, together with a copy of the purchase receipt, within the aforesaid warranty period.

Anything in the foregoing to the contrary notwithstanding, Panasonic shall have no obligation for any defects in the disk(s) or other media on which the Programs are furnished resulting from your storage thereof, or for defects that have been caused by operation of the disk(s) or other media otherwise than on the Product or in environmental conditions other than those specified by Panasonic by alteration, accident, misuse, abuse, neglect, mishandling, misapplication, installation, maladjustment of consumer controls, improper maintenance, modification of damage that is attributable to acts of God. In addition, Panasonic shall have no obligation for any defects in the disk(s) or other media if you have modified, or attempted to modify any Program.

DURATION OF IMPLIED WARRANTIES, IF ANY, IS LIMITED TO SIXTY (60) DAYS.

PANASONIC ASSUMES NO RISK OF AND SHALL NOT IN ANY CASE BE LIABLE FOR ANY DAMAGES, INCLUDING, WITHOUT LIMITATION, ANY SPECIAL, INCIDENTAL, CONSEQUENTIAL, OR PUNITIVE DAMAGES ARISING FROM BREACH OF WARRANTY OR CONTRACT, NEGLIGENCE OR ANY OTHER LEGAL THEORY, INCLUDING, WITHOUT LIMITATION LOSS OF GOODWILL, PROFITS OR REVENUE, LOSS OF USE OF THE PROGRAMS OR PRODUCTS OR ANY ASSOCIATED EQUIPMENT, COST OF CAPITAL, COST OF ANY SUBSTITUTE EQUIPMENT, FACILITIES, SERVICES, DOWNTIME COSTS, OR CLAIMS OF ANY PARTY DEALING WITH YOU FOR SUCH DAMAGES.

Some states do not allow the exclusion or limitation of incidental or consequential damages, or limitations on how long an implied warranty lasts, so the above limitations or exclusions may not apply to you.

This limited warranty gives you specific legal rights, and you may also have other rights which vary from state to state.

This Limited Warranty will be governed by the laws the State of New York, without regard to its conflict-of-laws rules.

* * *

To obtain service or technical assistance within the continental U.S.A. and Alaska.

DIAL TOLL FREE: 1-800-LAPTOP5

Correspondence requesting product information should be sent to: Panasonic Computer Solution Company,
50 Meadowlands Parkway, Panazip 2F-5, Secaucus, NJ 07094

For Canada

PANASONIC COMPUTER AND PERIPHERALS LIMITED WARRANTY

Coverage – Panasonic Canada Inc. (“PCI”) warrants to you, the first end user customer, this computer product (excluding software media), when purchased from PCI or from a PCI authorized reseller, to be free from defects in materials and workmanship under normal use, subject to the terms set forth below, during the period of warranty coverage specified.

Scope of Coverage	Period of Coverage	Type of Failure Coverage
Whole Product (except Batteries), AC adaptor and CD-ROM (if factory installed)	Three (3) Years from Date of Original End User Customer Purchase	Defective Materials or Workmanship
Batteries, CD-ROM (unless factory installed), Port Replicator, Extra Memory Modules and all other Peripherals, Options and Accessories	One (1) Year from Date of Original End User Customer Purchase	Defective Materials or Workmanship

Remedy – In the event of a warranty claim, contact PCI’s representatives within the applicable warranty period, identifying the nature of the defect claimed, at 1-800-668-8386 between 9:00 A.M. and 5:00 P.M., Eastern Time Zone, Mon. – Fri. (excluding holidays) for instructions on how to obtain service. A purchase receipt or other proof of date of original purchase is required before warranty service is performed. Defective parts covered by this Limited Warranty will be repaired or replaced with new or comparable rebuilt parts on an exchange basis. Warranty replacement or repair is subject to the terms of this Limited Warranty for the balance of the original period of warranty coverage.

No Coverage – This Limited Warranty does not cover products purchased outside Canada. Neither does it cover damage to, failure of, or defects in a product or accessory through mishandling, improper installation, abnormal use, misuse, neglect, accident, introduction of liquid or other foreign matter into the product, alteration or servicing by anyone not authorized by PCI, or act of God.

IF YOU SHIP THE PRODUCT FOR WARRANTY SERVICE

Carefully pack the product, preferably in the original carton. Include details of defect claimed and proof of date of original purchase. No liability is assumed for loss or damage to the product while in transit, if you chose your own transportation carrier.

SOFTWARE MEDIA LIMITED WARRANTY

Coverage – Panasonic Canada Inc. (“PCI”) warrants to you, the first end user customer, that the disk(s) or other media on which software program(s) is/are supplied will be free from defects in materials and workmanship under normal use in Canada for a period of sixty (60) days from date of receipt as evidenced by your purchase receipt for your Panasonic Computer product.

THIS IS THE ONLY WARRANTY THAT PCI MAKES RESPECTING THE SOFTWARE MEDIA. PCI does not warrant the software. Please refer to the software licensor’s written warranty (accompanying the copy of the software) for any software warranty claim.

Claim Procedure – In the event of a defect in material or workmanship in the media during the sixty (60) day warranty period, and you return it, transportation costs prepaid, to Panasonic Canada Inc., Computer Products Marketing, at the above address, within the warranty period, together with a copy of your purchase receipt, and an explanation of the suspected defect, PCI will replace in Canada the defective disk(s) or other media.

Remedy – PCI’s entire liability, and your only remedy for any breach of this software media warranty is limited to replacement of the media only. It does not cover any other damages, including, but not limited to, loss of use or profit loss, or special, indirect or consequential damages, or other claims, whether or not of similar character.

No Coverage – This limited warranty does not apply if the disk(s) or other media has been used in other than a Panasonic product, or in environmental conditions other than those specified by PCI or the manufacturer, or if subjected to misuse, neglect, mishandling, modification or attempted modification of the program, or if damaged by accident or act of God. PCI is not responsible for damage to or loss of any program, data or removable storage media.

GENERAL

NO OTHER WARRANTIES – PCI DISCLAIMS ALL OTHER WARRANTIES, EITHER EXPRESS OR IMPLIED, INCLUDING, BUT NOT LIMITED TO, IMPLIED WARRANTIES OF MERCHANTABILITY AND FITNESS FOR A PARTICULAR PURPOSE, WITH RESPECT TO THE SOFTWARE, SOFTWARE MEDIA, COMPUTER PRODUCT, OPTIONS AND ACCESSORIES.

NO LIABILITY FOR CONSEQUENTIAL DAMAGES – IN NO EVENT SHALL PCI BE LIABLE FOR ANY SPECIAL, INDIRECT OR CONSEQUENTIAL DAMAGES ARISING FROM ANY BREACH OF THE LIMITED WARRANTIES SET OUT IN THIS DOCUMENT, OR FROM THE USE OF THE COMPUTER PRODUCT, INCLUDING, WITHOUT LIMITATION, LOSS OF DATA, BUSINESS, PROFIT OR GOODWILL.

IN ANY EVENT, PCI’S MAXIMUM LIABILITY FOR ANY BREACH SHALL NOT EXCEED THE AMOUNT ACTUALLY PAID BY YOU FOR THE COMPUTER PRODUCT.

NO ACTION, REGARDLESS OF ITS BASIS, MAY BE BEGUN AGAINST PCI MORE THAN TWO (2) YEARS AFTER THE CAUSE OF ACTION AROSE.

Statutory Warranties – Some jurisdictions do not allow these limitations or exclusions, so they may not apply to you.

Memo



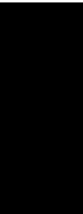



As an ENERGY STAR® Partner, Matsushita Electric Industrial Co., Ltd. has determined that this product meets the ENERGY STAR® guidelines for energy efficiency.

Outline of the International ENERGY STAR® Office Equipment Program

The international ENERGY STAR® Office Equipment Program is an international program that promotes energy saving through the use of computers and other office equipment. The program backs the development and dissemination of products with functions that effectively reduce energy consumption. It is an open system in which business proprietors can participate voluntarily. The targeted products are office equipment such as computers, displays, printers, facsimiles, and copiers. Their standards and logos are uniform among participating nations.

Panasonic Computer Solution Company,

50 Meadowlands Parkway, Panazip 2F-5,
Secaucus, NJ 07094

Panasonic Canada Inc.

5770 Ambler Drive Mississauga,
Ontario L4W 2T3

